

SEA BB 42" by Dz1sfb

GENERAL ARRANGEMENT

Wingspan - 42"  
Length - 36-3/8"  
Height - 13-5/16"  
Weight - 16-3/4 oz.

PROTOTYPE EQUIPPED WITH:

Motor and ESC - Suppo 2208-14 Super Cheap Combo with 18 Amp ESC  
Prop - APC 8" x 3.8" SF  
Battery - 3s 1300 Mah Lipo  
Servos - 2 Hitec HS-55  
Receiver - Spektrum AR6100

FOR PRIVATE USE ONLY  
COMMERCIAL RIGHTS RESERVED

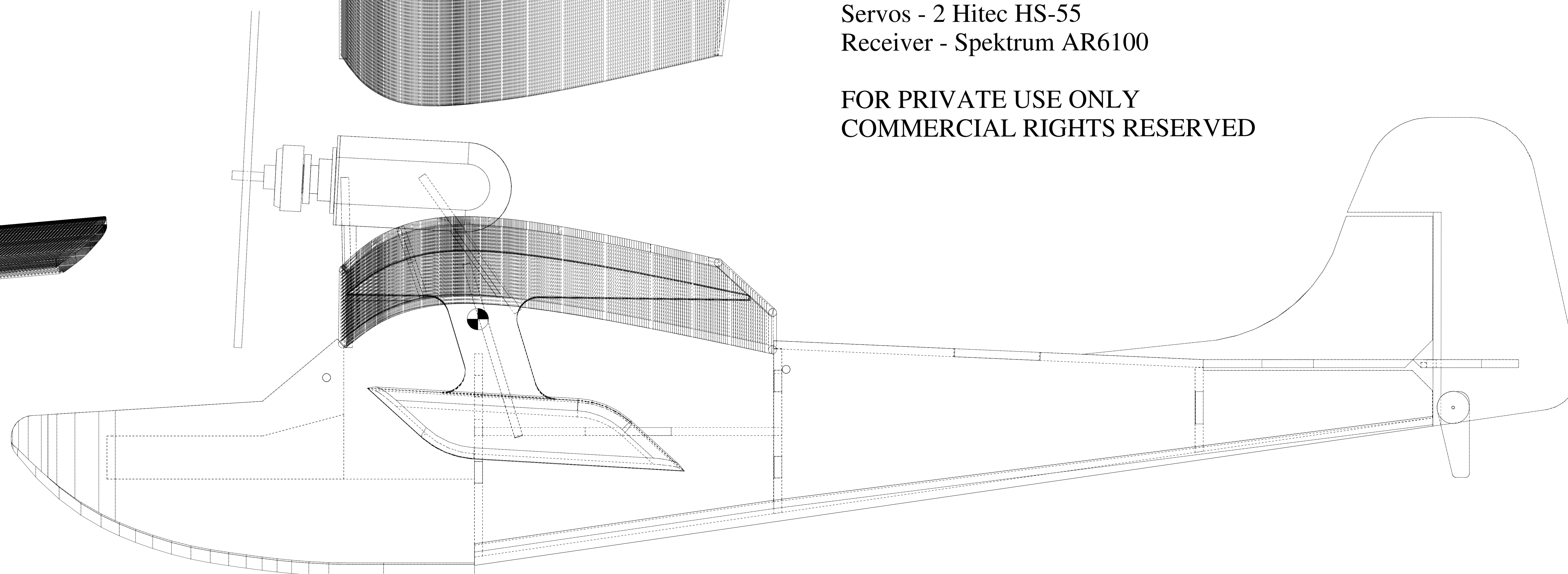
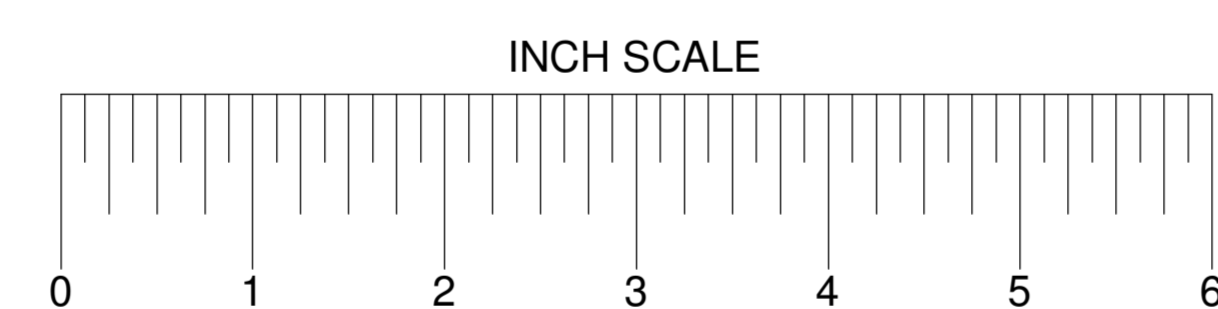
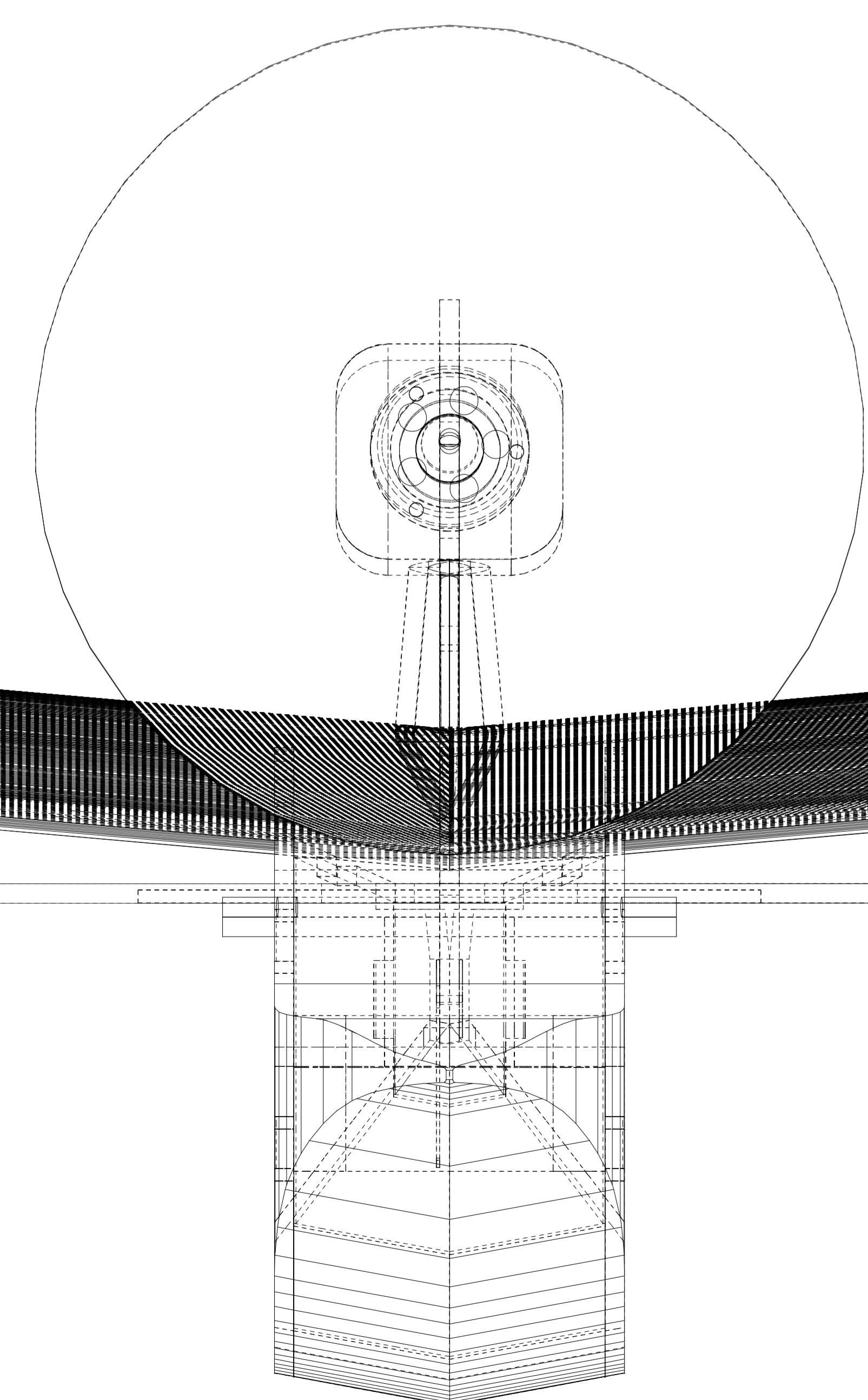

Sea BB 42"

Exploded View

Note;

Not all parts in this view represent the finished product.

This is a work in progress, and tabbed construction was being added at this time, therefore there are some discrepancies in this drawing.

For private use only.  
Commercial rights reserved.

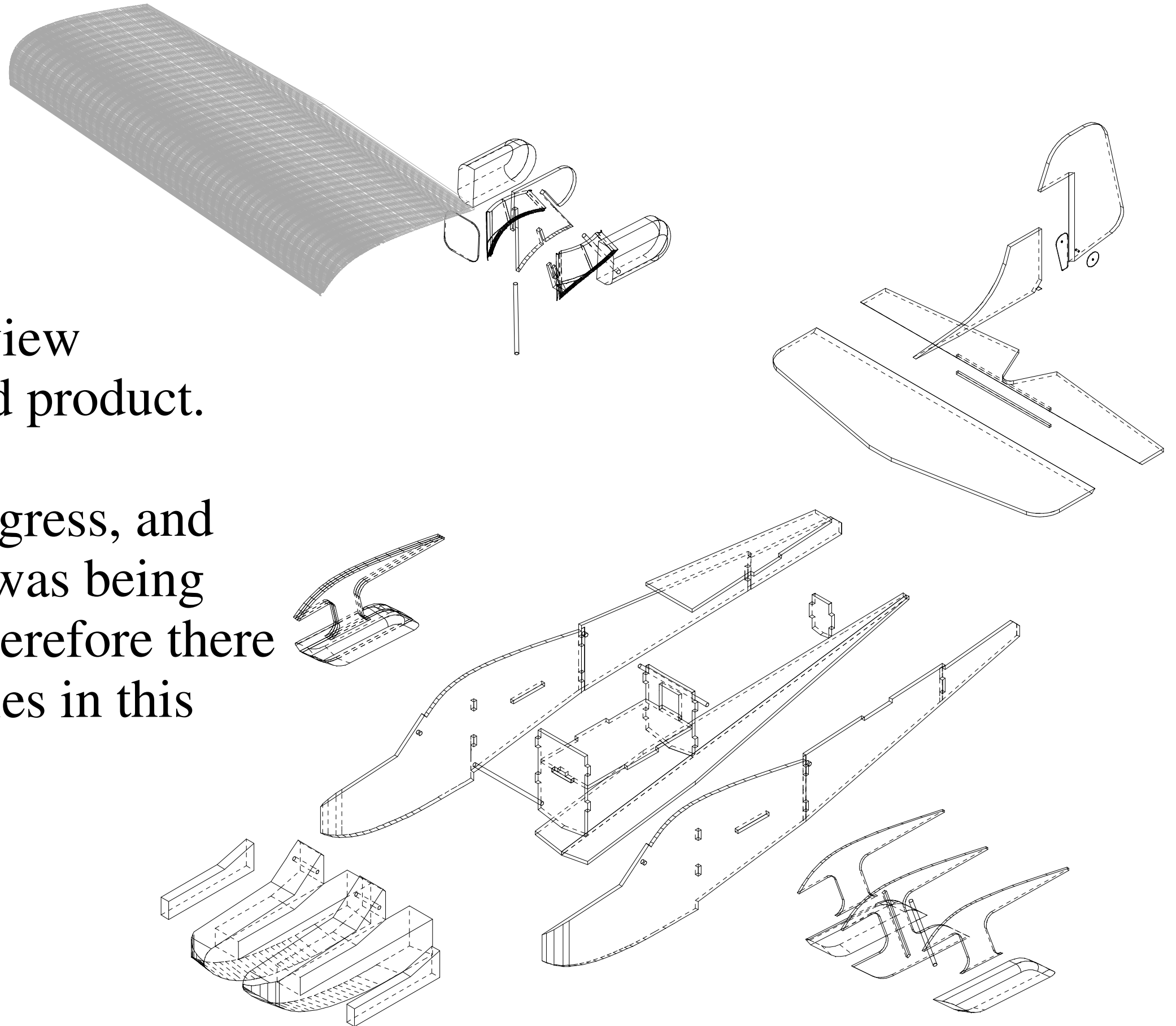

**NOTE**

ALL PARTS ARE FAN FOLD FOAM  
DOW PROTECTION BOARD III  
UNLESS SPECIFIED OTHERWISE.

OTHER MATERIALS REQUIRED FOR BUILD INCLUDE:  
1.5" FOAM - MONOBLOCK, WINGTIP FLOATS, AND  
MOTOR PYLON CHEEK BLOCKS  
2 - 3/16" X 48" DOWEL RODS - WING LE & TE, WINGTIP  
FLOATS, AND MOTOR PYLON REINF.  
1/16" PLYWOOD - MOTOR MOUNT AND CONTROL  
HORNS  
1 - 1/8" X 48" DOWEL ROD - PUSHRODS  
1 - 1/32" MUSIC WIRE - PUSHRODS

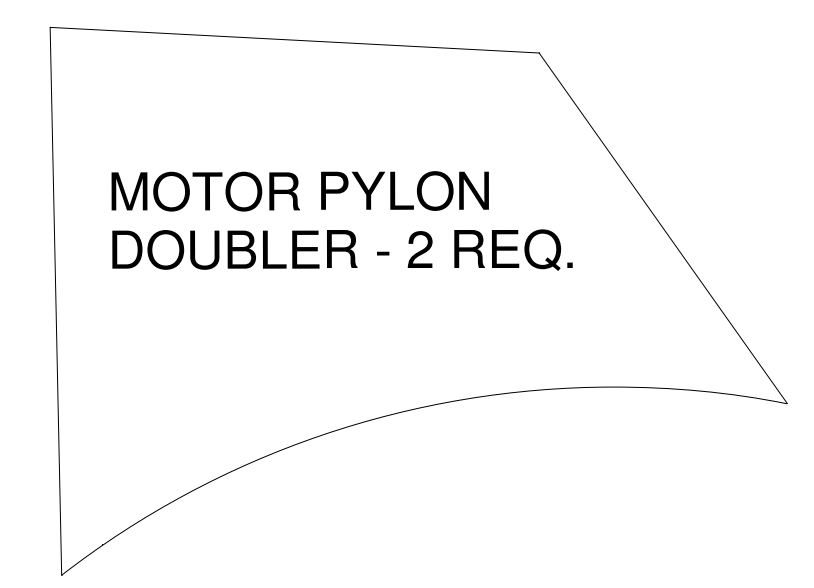
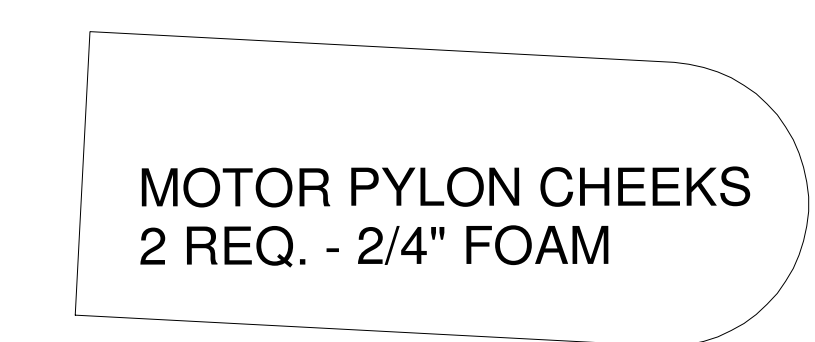
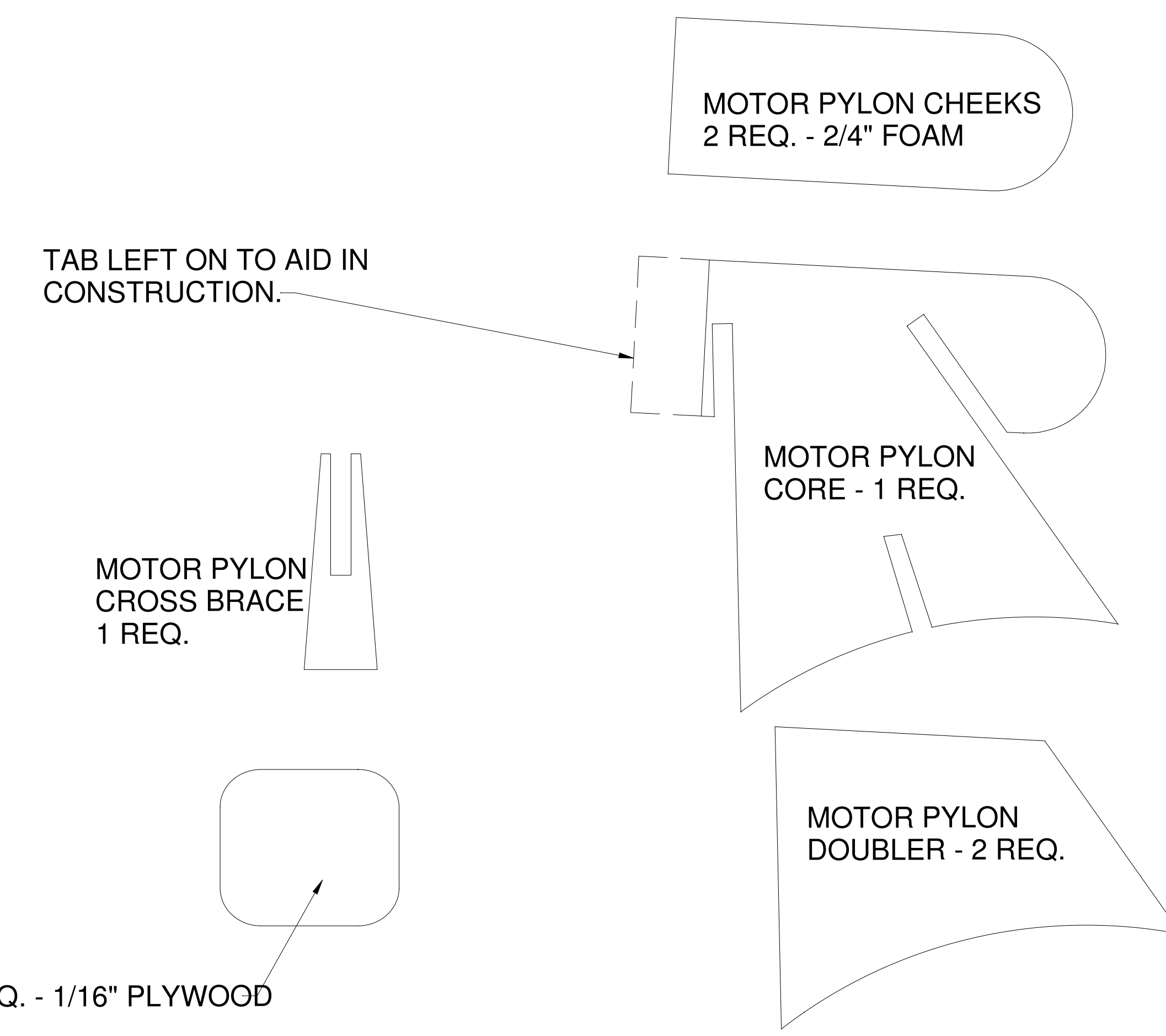
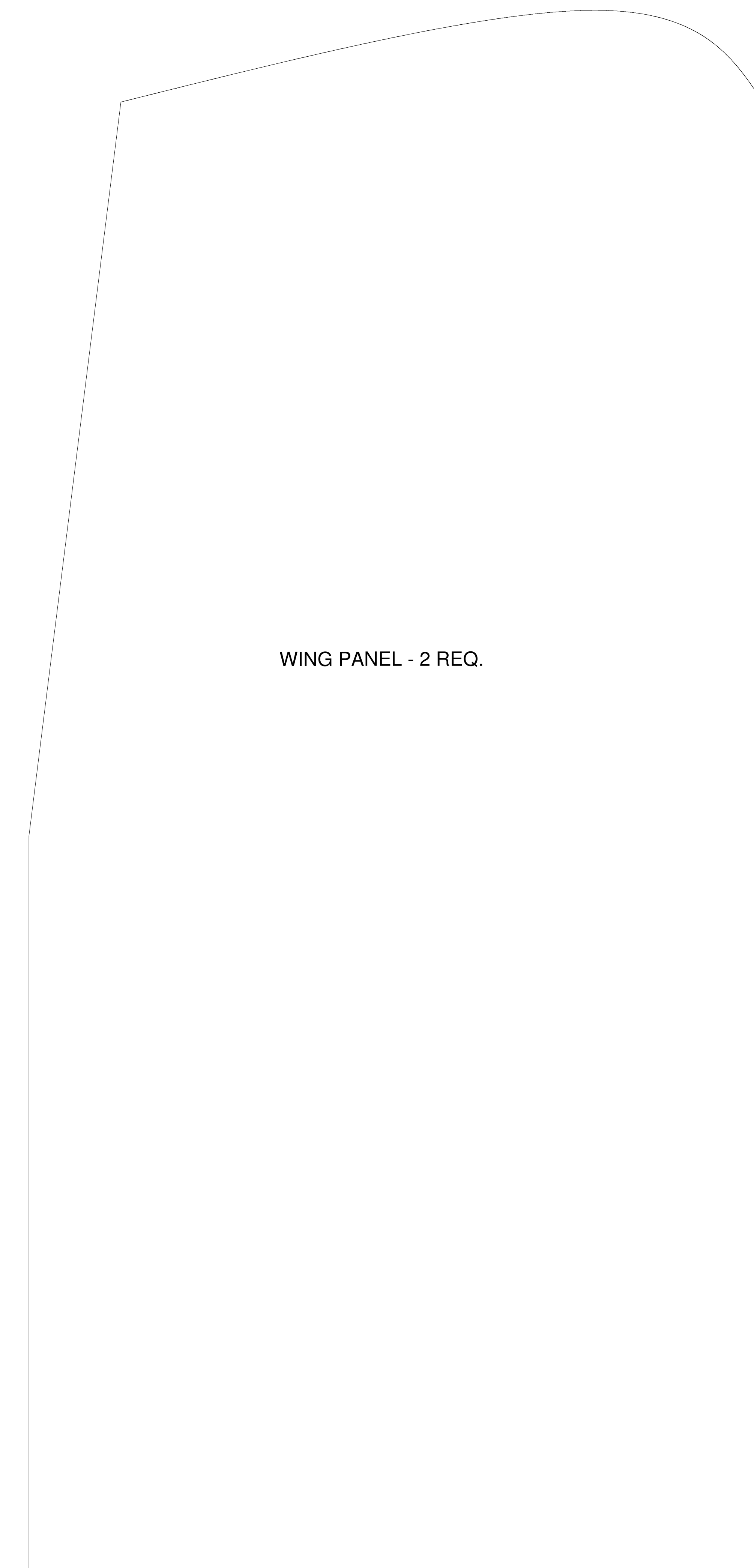
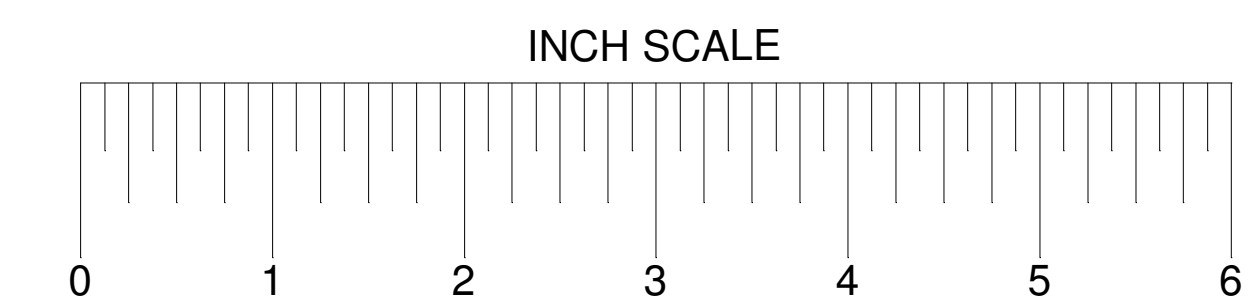
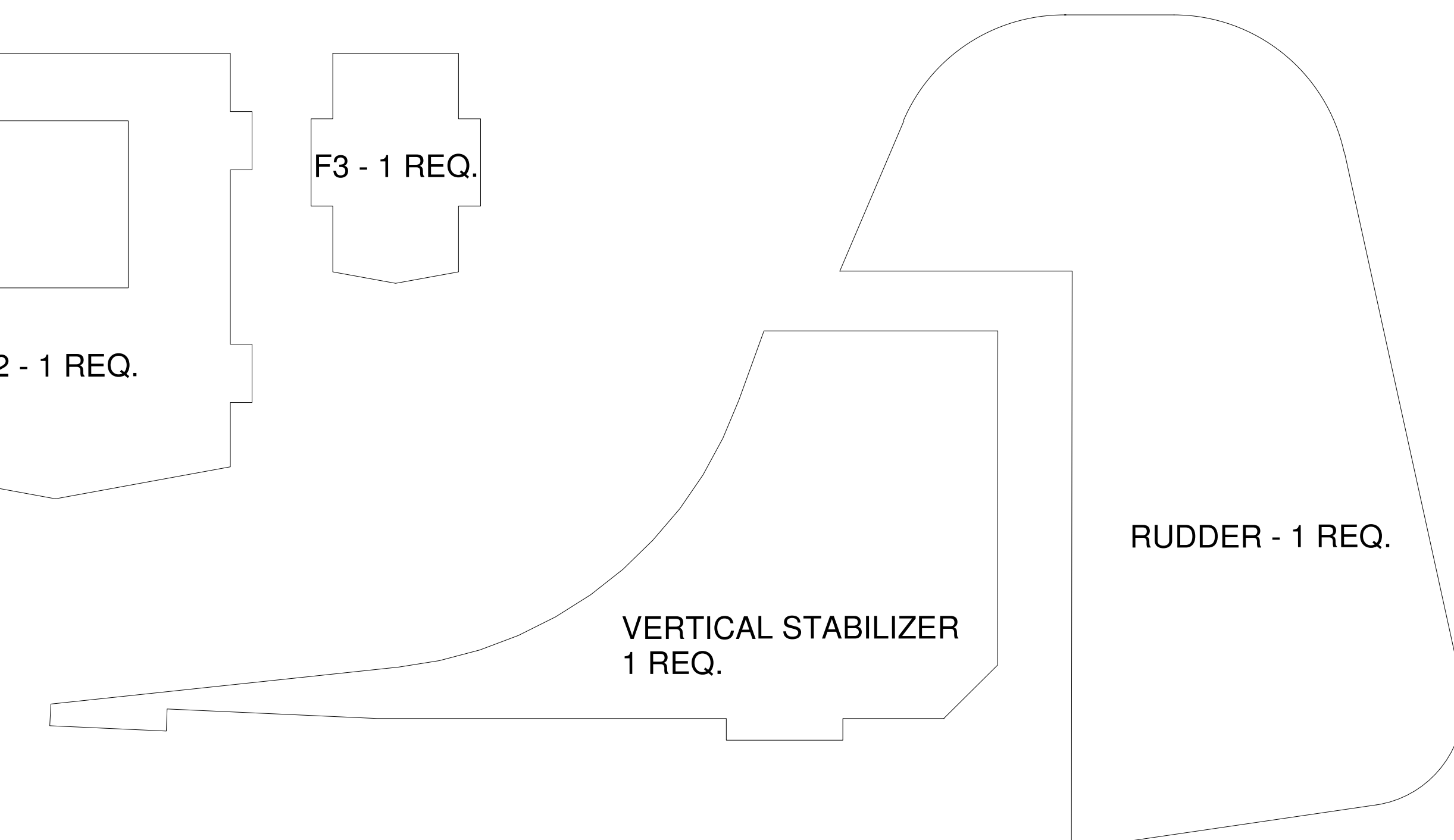
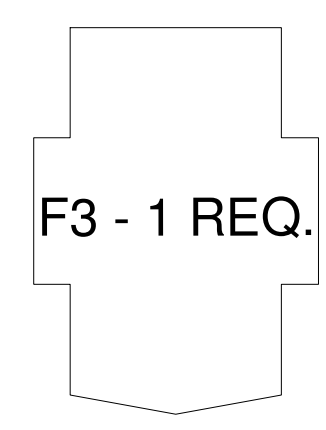
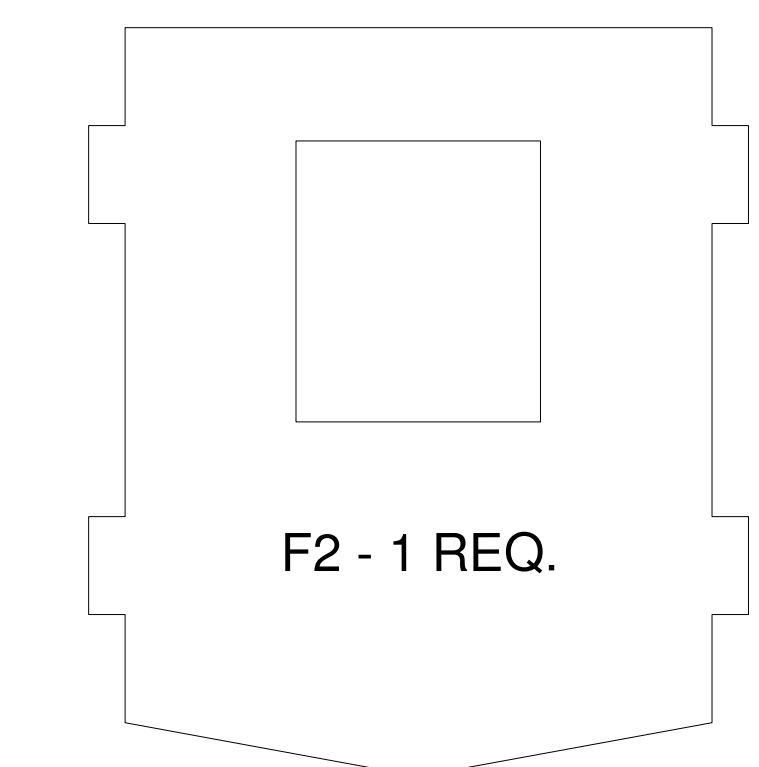
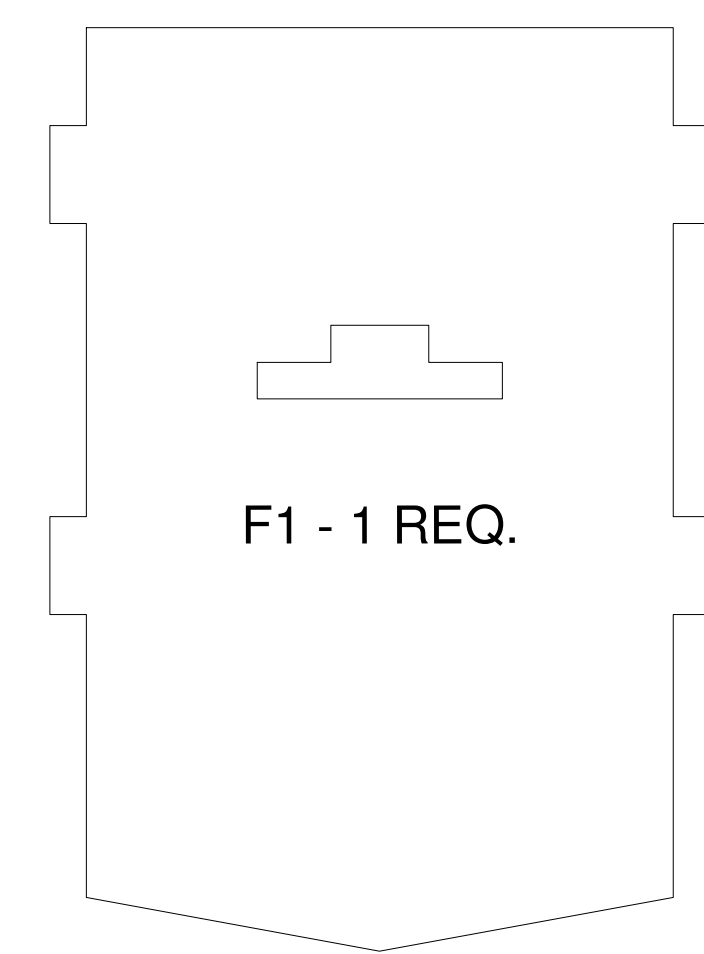
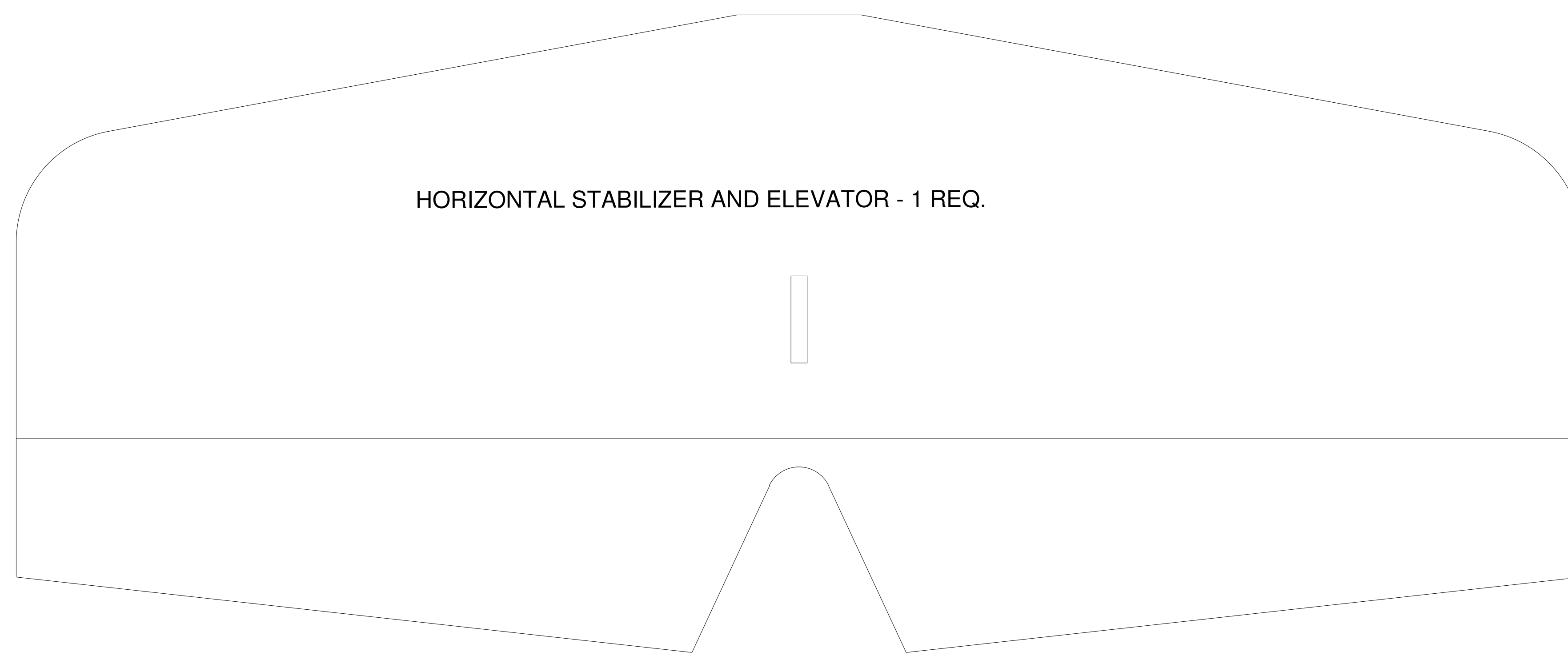
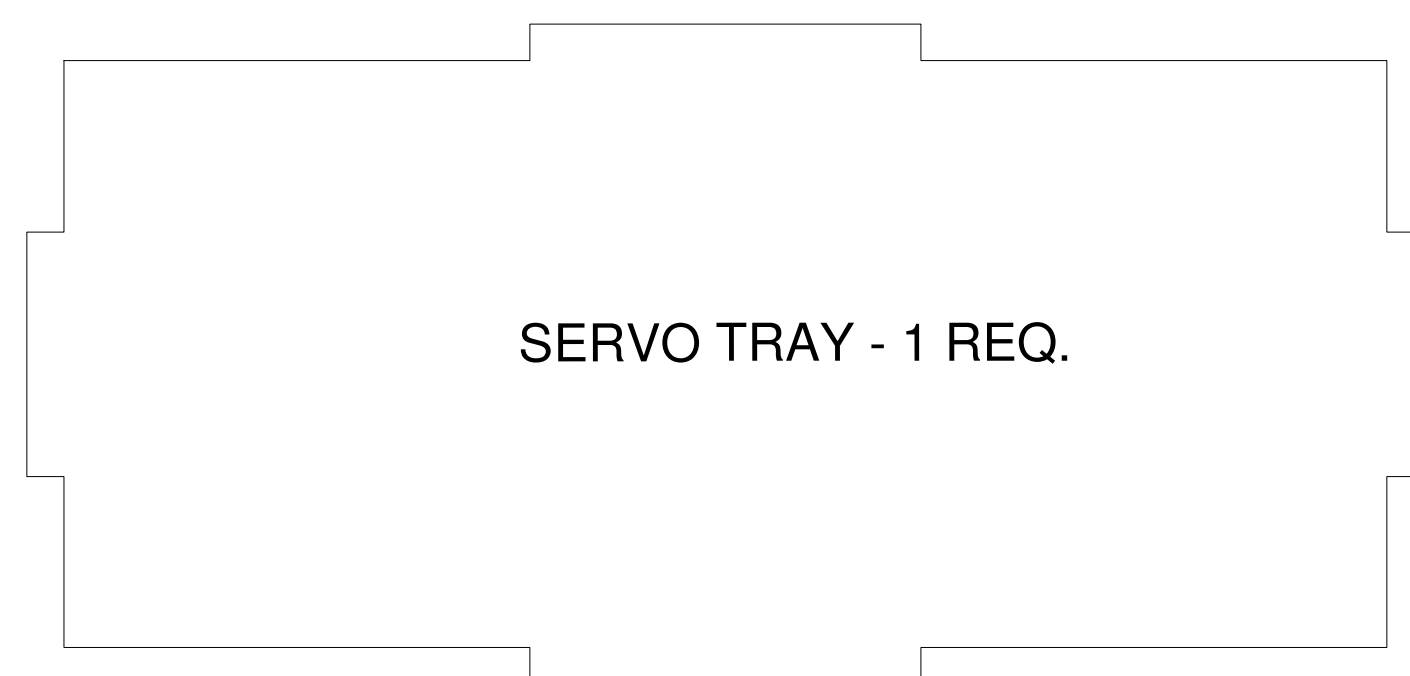
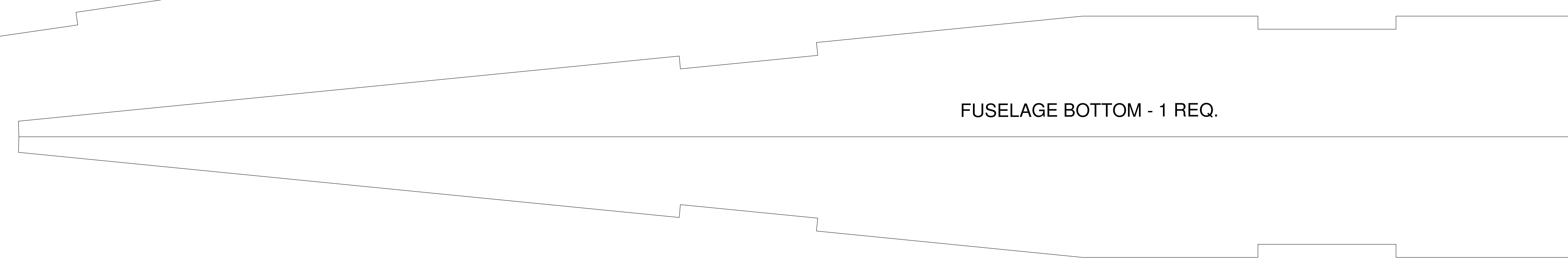
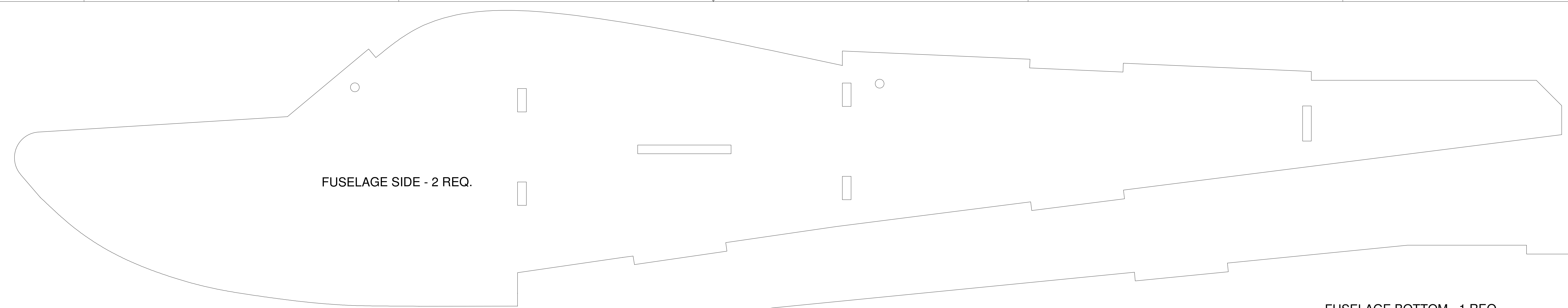

TAB LEFT ON TO AID IN CONSTRUCTION.

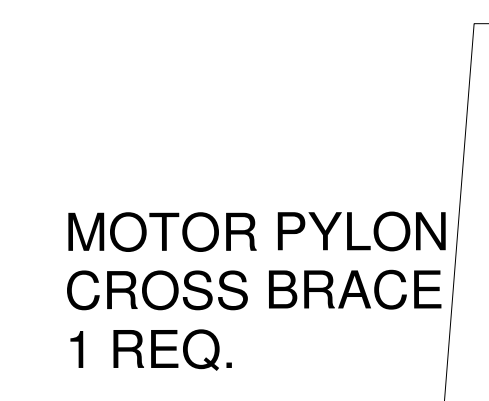

MOTOR MOUNT - 1 REQ. - 1/16" PLYWOOD

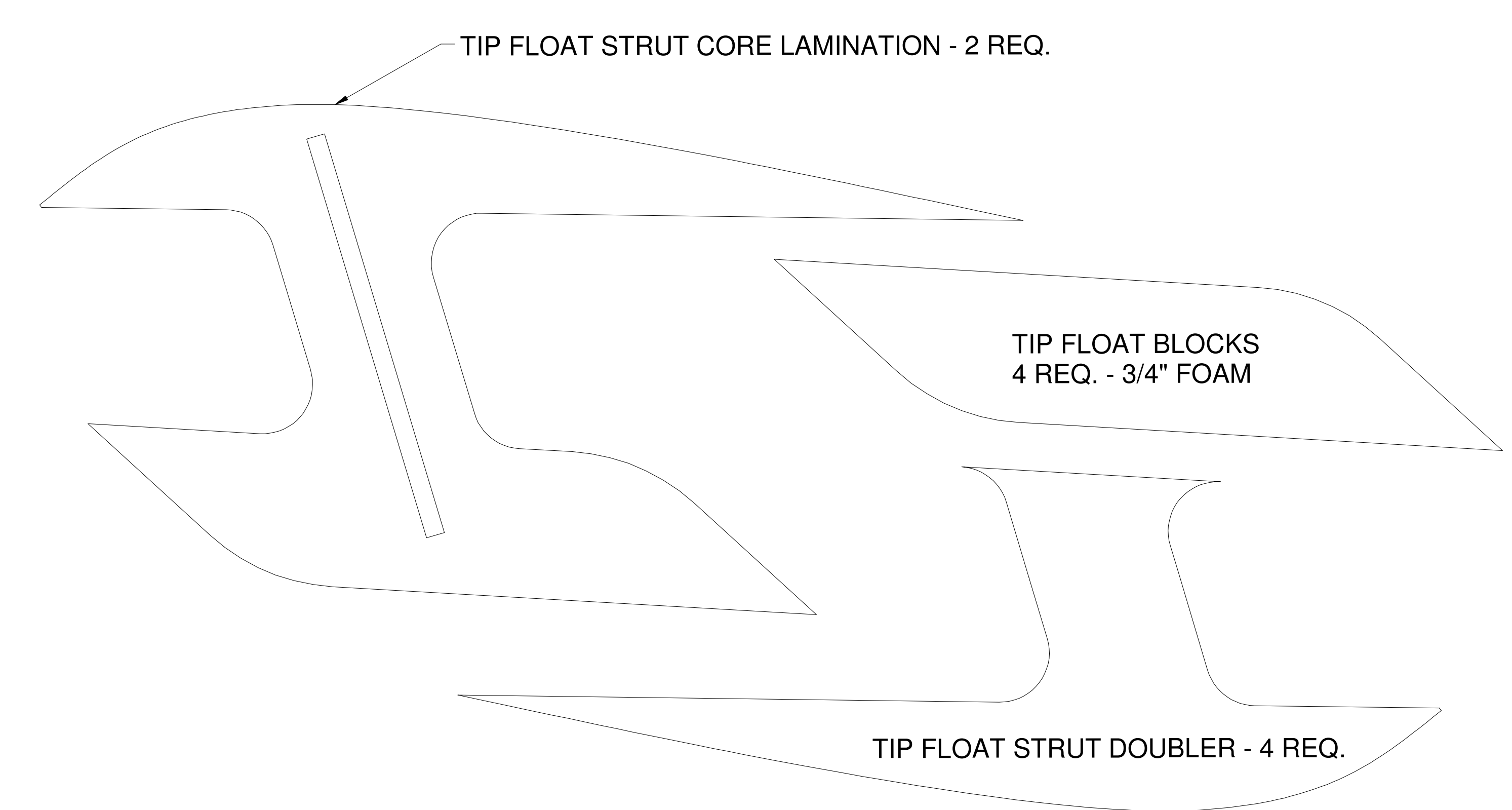

TIP FLOAT BLOCKS  
4 REQ. - 3/4" FOAM

TIP FLOAT STRUT DOUBLER - 4 REQ.

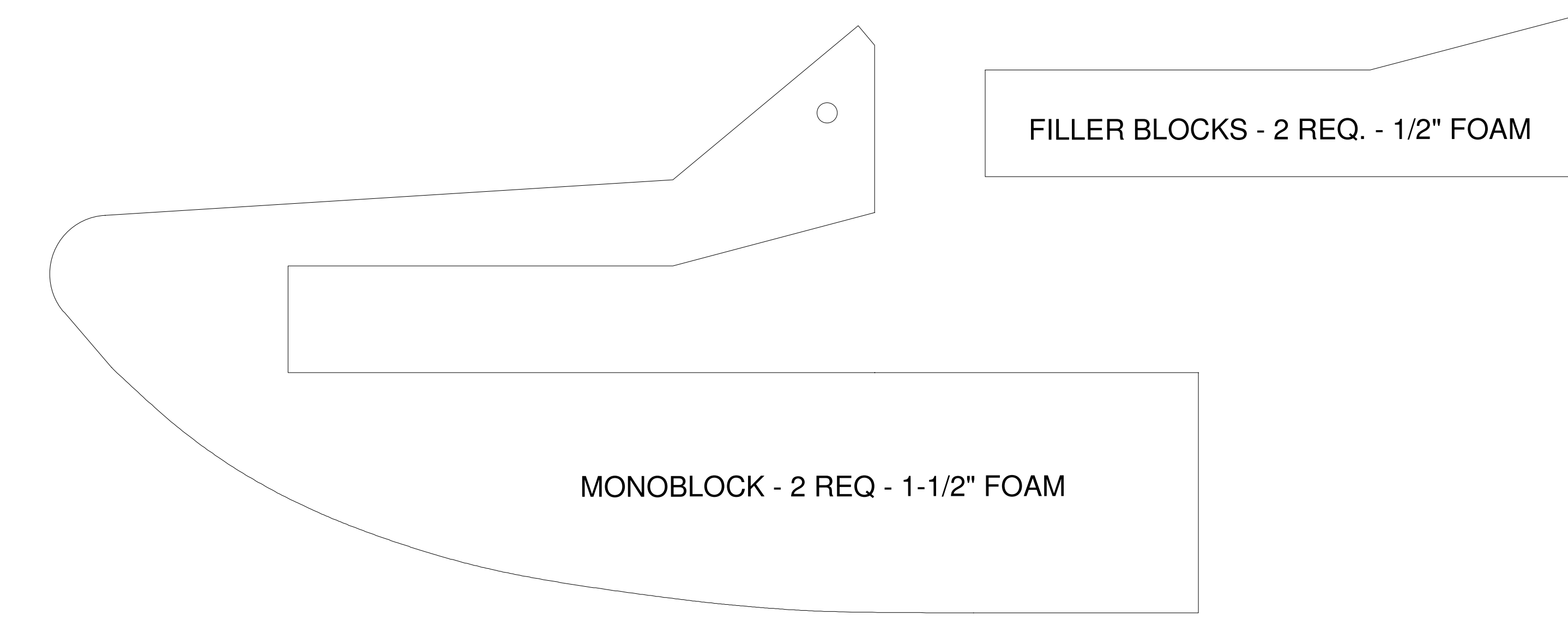

FILLER BLOCKS - 2 REQ. - 1/2" FOAM

FOR PRIVATE USE ONLY  
COMMERCIAL RIGHTS  
RESERVED.

TITLE		Designed by dz1sfb for the Blu-Baby Tribute Design Contest. Based on Tony65x55's Blu-Baby 42"	
SIZE	CAGE CODE	REV	REL
SCALE	FULL	16-NOV-2008	SHEET

Sea BB window and door trim mask

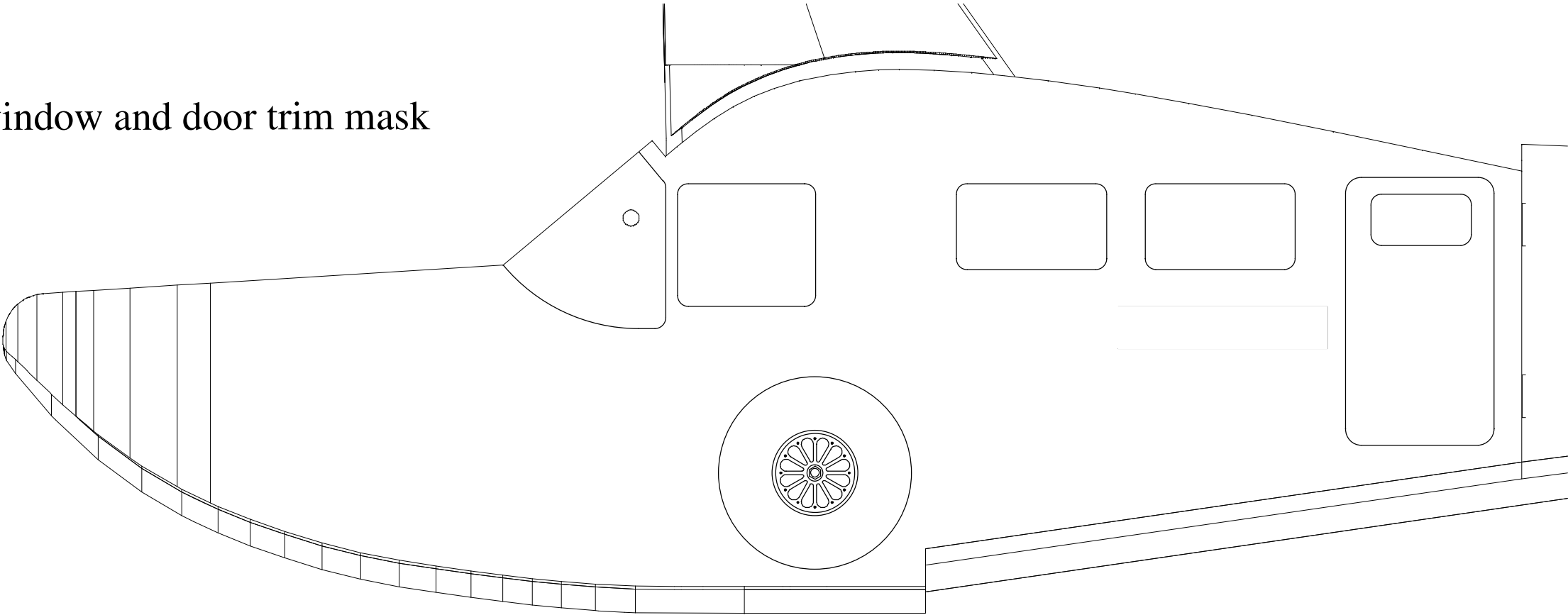

# SEA BB 42" DIHEDRAL SETTING TEMPLATE

